



## **Multiwall Polycarbonate Sheets and Systems**

Enlight Your Projects

**AkyVer**<sup>®</sup>Sun Type

**AkyVer**<sup>®</sup>Panel

**AkyVer**<sup>®</sup>Connect

**akyver**<sup>®</sup>

# EXPERTISE

## More than 40 Years of Expertise.

**AkyVer®** is a complete range of multiwall polycarbonate sheets and systems. For more than 40 years, **AkyVer®** has been able to combine the quality of its products together with technical performance and aesthetic design to meet a variety of architectural projects.



› More than 40 years of expertise

AkyVer® brand expresses durability and quality proven over the years through long term partnerships with our customers.



› Dedicated sales and technical experts

Our team of experts accompany you from your project to the realization on site.



› Local Production International scope

With production based in Nera Montoro, in Italy, Exolon Group serves the whole of Europe and beyond.

## High Environmental Quality

“Closing the Loop” is a program which we have initiated to minimize waste throughout the value chain. Many of our dealers and processors already salvage their scrap and waste, supplying these to recycling companies from which we obtain high-quality material. New partners are always welcome, as recycle is unfortunately still a scarce resource today.

## Closing the Loop – with the Exolon Group



ISO 14001  ENVIRONMENTAL MANAGEMENT

# OVERVIEW

## AkyVer® Sun Type SHEETS

2 walls



Ceilings, inside space dividers, greenhouses, swimming pool covers

4 walls



Skylights, industrial greenhouses

7 walls

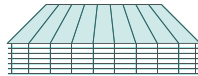

Skylights, stadiums

10 walls

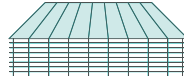

Wintergarden, verandas

## AkyVer® Panel CLIP SYSTEMS

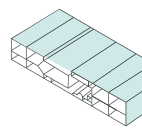

Panel 40-3

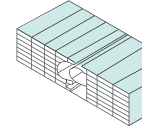

Panel 40-8

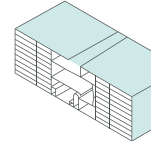

Panel 50

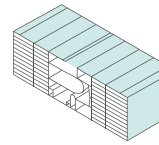

Panel 60

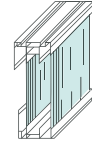

PanelTherm

New or renovation claddings, facades, sheds, for industrial, sport, commercial, logistic, fire station buildings.

## AkyVer® Connect SYSTEMS

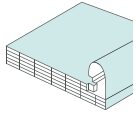

Connect 16

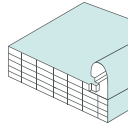

Connect 25

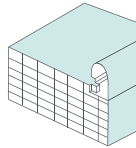

Connect 40

New or renovation claddings or roofing, Sheds, ventilated facades for industrial Sport, commercial, logistic buildings, fire station buildings.

## AkyVer® Prime

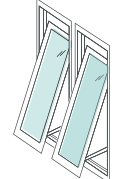
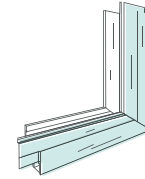
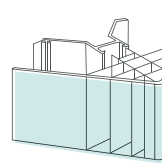

Windows, Alu and polycarbonate corners

Help for installation to complete the range and to facilitate your fittings

## AkyVer® ACCESSORIES

PE foam

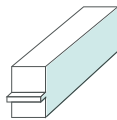

Sealing

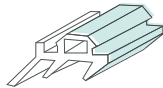

Link Plate

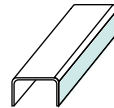

End profile

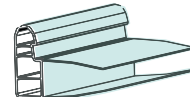

Thermal brake profile

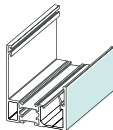

Cold profile

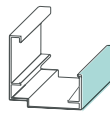

Closing part



Start profile

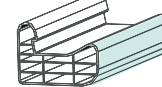

Sheet plug

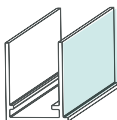

Hooks

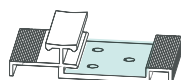

Connector



Retaining bracket





# AkyVer® Sun Type

Polycarbonate  
multiwall sheets

From 4mm (2 walls)  
to 50 mm (10 walls)



# AkyVer® Sun Type

Polycarbonate multiwall sheets offer thermal insulation, lightness, cold bending possibility and impact resistance.

Thanks to extra anti UV treatment by coextrusion, they ensure over time excellent weather and UV rays' resistance. They provide as well highly stable mechanical properties.

The highest balance between thermal insulation, light transmission and mechanical performance

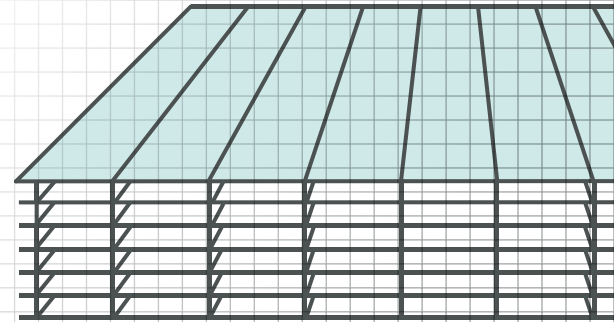

## › Technical Characteristics

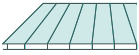
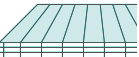
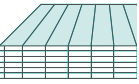
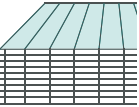
	Thickness (mm)	Weight (g/m <sup>2</sup> )	Thermal insulation (W/m <sup>2</sup> . °C)	Light Transmission CLEAR (%)	Light Transmission OPAL (%)
 2 walls	4	800	3.9	84	64
	6	1300	3.6	82	63
	8	1500	3.4	82	61
	10	1700	3.1	81	60
	16	2400	2.4	78	58
 4 walls	10	1750	2.5	62	56
	16	2600	<1.8	58	54
 7 walls	20	2800	1.5	58	54
	25	3400	<1.4	56	52
	25	3400	<1.4	52	46
 10 walls	32	3500	<1.1	52	44
	40	4000	<1.0	50	41
	50	4500	0.8	48	35

# AkyVer®

## Panel + PanelTherm

AkyVer® Panel 40-3W  
AkyVer® Panel 40-8W  
AkyVer® Panel 50-10W  
AkyVer® Panel 60-12W

Multi-wall polycarbonate  
clip-on systems



# AkyVer® Panel

Clip-on polycarbonate multiwall system from 3 to 12 walls. High light transmission and quick to install.

- > Airtightness
- > Excellent load capacity
- > Fast fitting

# AkyVer® PanelTherm

Clip systems double or triple-skin in multiwall polycarbonate.

- > Record thermal insulation
- > High acoustic insulation
- > Meets HQE standards

Let the natural light in your buildings!

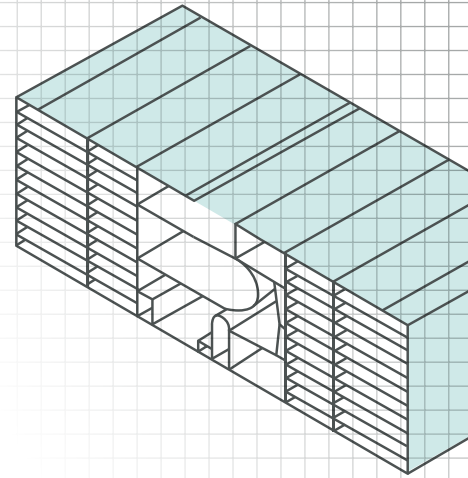

## > Technical Characteristics

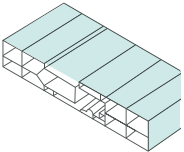
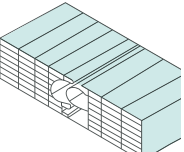
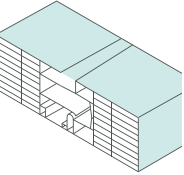
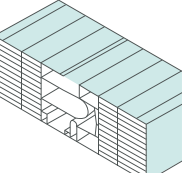
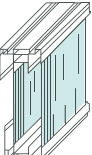
		Thickness (mm)	Weight (g/m <sup>2</sup> )	Thermal insulation (W/m <sup>2</sup> . °C)	Light Transmission (%)	
	Panel 40-3	40	3500	1.7	Trans	72
					Opal	48
	Panel 40-8	40	4000	0.98	Trans	52
					Opal	36
	Panel 50-10	50	5000	0.83	Trans	43
					Opal	28
	Panel 60-12	60	5800	0.75	Trans	42
					Opal	26
	Panel Therm Standard/Acoustic	130 (142mm profile width)	8000 8800-17600	0.51 0.50	Trans	25 19



# AkyVer® Connect

AkyVer® Connect 16

AkyVer® Connect 25

AkyVer® Connect 40

Multi-wall polycarbonate  
connectable systems



# AkyVer® Connect

Connectable systems in multi-wall polycarbonate. Complete range of aluminium and thermal break sections.

- › Accessories for fast, professional fitting
- › Bendable

*The solution for all applications such as roofing and cladding, flat or cold bended !*

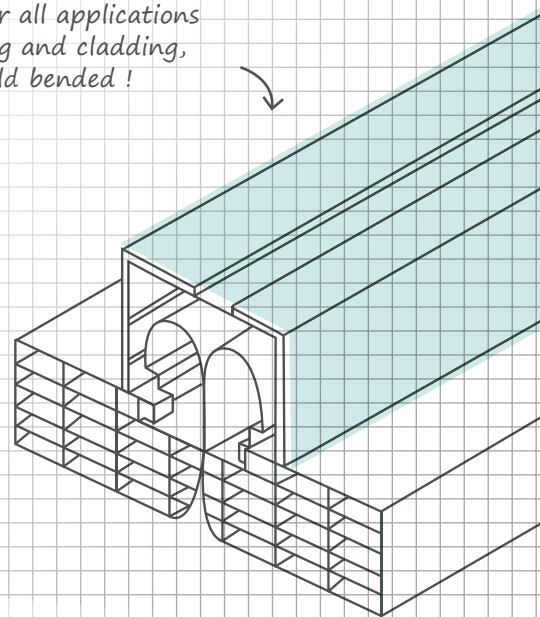

## › Technical Characteristics

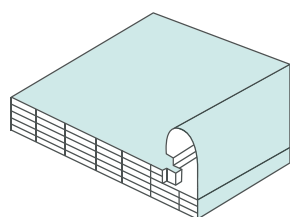

Connect 16

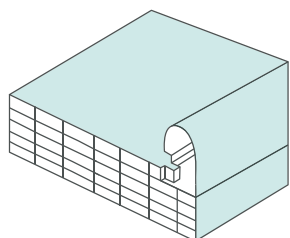

Connect 25

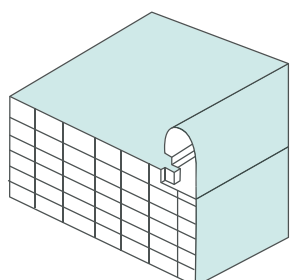

Connect 40

	Thickness (mm)	Weight (g/m <sup>2</sup> )	Thermal insulation (W/m <sup>2</sup> . °C)	Light Transmission (%)	
Connect 16	16	3200	1.8	Trans	59
				Opal	41
Connect 25	25	3600	1.4	Trans	55
				Opal	35
Connect 40	40	4400	1.0	Trans	53
				Opal	37



# AkyVer® Finishes



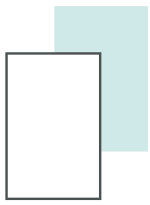

> **Duocolor**

Two colours one the same sheet (internal/external)

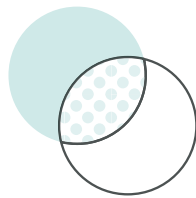

> **LiteStop**

Completely opaque  
Reduced greenhouse effect  
Reduced thermal expansion

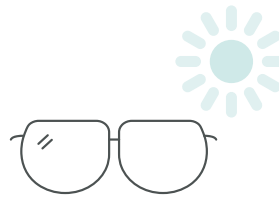

> **Anti-dazzle**

High visual comfort  
Reduced dazzle

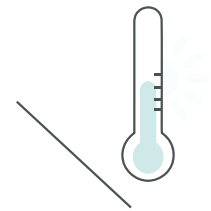

> **IR control**

Reduced greenhouse effect



> **Iridescent Heat Block**

Reduced greenhouse effect, creative effect or iridescence

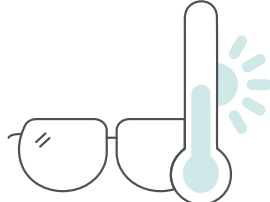

> **Comfort T**

Reduced greenhouse effect  
Reduced dazzle

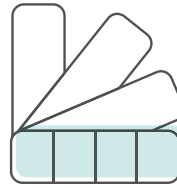

> **Colours**

Creative effect on your buildings

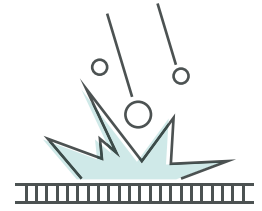

> **HR (Hail Resistant)**

High resistance to hail  
Uv reinforced  
Fully guarantee for 10 years

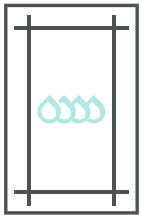

> **Silk-screen**

Creative effect for unique building



> **Anti-Graffiti**

Facilitates the cleaning of graffiti on your buildings and protects against abrasion

> **Technical Characteristics**

	AkyVer® Sun Type	AkyVer® Panel				AkyVer® PanelTherm		AkyVer® Connect		
Type of finishes	4 -50	P40-3W	P40-8W	P50	P60	-	C16	C25	C40	
Colours	•	•	•	•	•	•	•	•	•	
Duocolor				•	•		•	•	•	
LiteStop	•			•	•		•	•	•	
Anti-Dazzle	•	•	•			•				
Anti-Dazzle Frosted				•	•		•	•	•	
HR High Hail Resistance	•									
IR Control	•		•			•				
Heat Block				•	•		•	•	•	
UV 2 sides	On request						•	•	On request	
Confort T	•	•	•	•	•	•	•	•	•	
Anti-Graffiti	•	•	•	•	•	•	•	•	•	
Silk-screen	•	•	•	•	•	•	•	•	•	

## AkyVer® Windows with thermal break

Various methods and directions of opening

Very resistant to extreme climate conditions.

Specially designed for integration with our **AkyVer® Panel** and **AkyVer® Connect** systems

- › Thermal break profiles for energy efficiency
- › Durable and lightweight structure.
- › Fast and easy to install, reducing the cost of installation.
- › Pre-glazed or can be installed at the site.

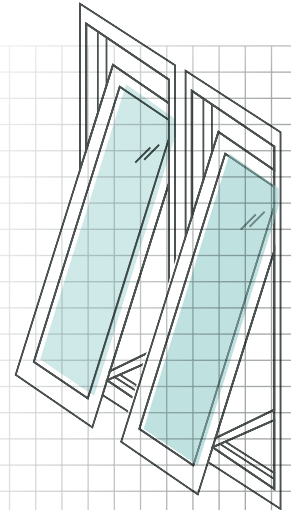

## AkyVer® Corner profile

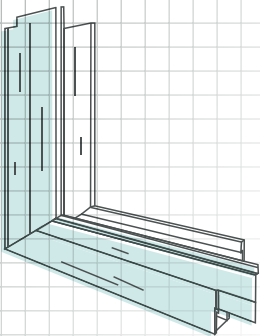

### Aluminium corner systems

This turnkey solution helps during the installation to avoid waste of time in corner cuts.

### Polycarbonate corner systems

Its translucent properties offers the unique opportunity to have an impactful building design and many advantages such as :

- › Aesthetical design
- › Fast and easy installation
- › Compatibility with all thicknesses of **AkyVer® Panel** range

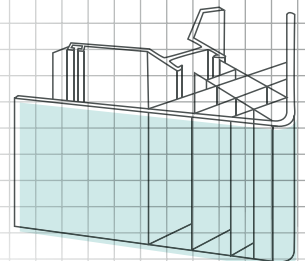

## CONTACT



Exolon Group S.p.A  
Strada Di Vagno 15/A –  
05035 Nera Montoro (TR)  
Italy

akyver@exolongroup.com  
www.exolongroup.com



The manner in which you use and the purpose to which you put and utilize our products, technical assistance and information (whether verbal, written or by way of production evaluations), including any suggested formulations and recommendations, are beyond our control. Therefore, it is imperative that you test our products, technical assistance, information and recommendations to determine to your own satisfaction whether our products, technical assistance and information are suitable for your intended uses and applications. This application-specific analysis must at least include testing to determine suitability from a technical as well as health, safety, and environmental standpoint. Such testing has not necessarily been done by Exolon Group. Unless we otherwise agree in writing, all products are sold strictly pursuant to the terms of our standard conditions of sale which are available upon request. All information and technical assistance is given without warranty or guarantee and is subject to change without notice. It is expressly understood and agreed that you assume and hereby expressly release us from all liability, in tort, contract or otherwise, incurred in connection with the use of our products, technical assistance, and information. Any statement or recommendation not contained herein is unauthorized and shall not bind us. Nothing herein shall be construed as a recommendation to use any product in conflict with any claim of any patent relative to any material or its use. No license is implied or in fact granted under the claims of any patent. AkyVer® is a registered trademark by Exolon Group.  
Edition: 2025 · Order-No.: MF0542 e ·